

PMC™ G2 JX 350-23



5075
PSI

23
L/PM

JX750 V-TWIN
PETROL
ENGINE TYPE



GEARBOX
1450RPM
DRIVE

COLD
WATER
OUTPUT

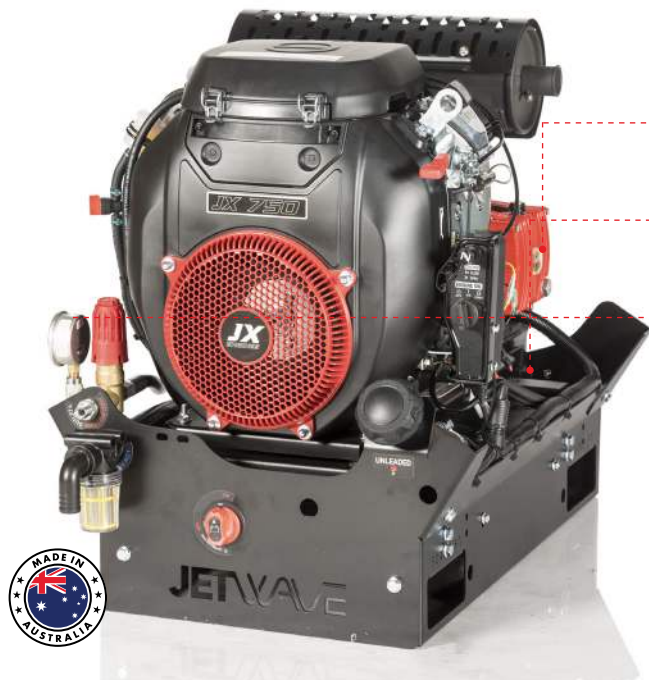

HERO INNOVATIONS



JWPP™
Jetwave Italian Premium Pump



AVPS™
Anti Vibration Protection System



PMC™
Panel/Bulk Head Mounted HP/LP Points



TURN KEY SOLUTION
Quality assured and ready to go

APPLICATIONS

- High Pressure Cleaning
- Drain Cleaning/Water Jetting
- Truck, Ute & Trailer Mounting
- External Water Tank & Bypass Ready



STANDOUT FEATURES

- JW® Enhanced Italian triplex plunger pump running at 1450RPM delivers more performance and longer life.
- Electric start Industrial V-Twin JX750 Series Engine.
- Jetwave Safety System™ (JSS) safety valve to prevent over pressurisation.
- Seamless 25L on-board fuel tank under chassis mount, with level gauge.
- Battery isolator to prevent battery voltage loss, when not in use.
- Integrated forklift pockets & mounting points.

MOUNTING FOOTPRINT

DIMENSIONS (MM)

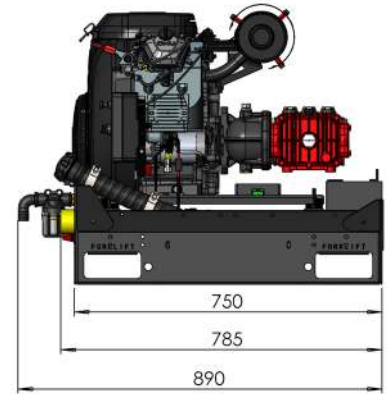
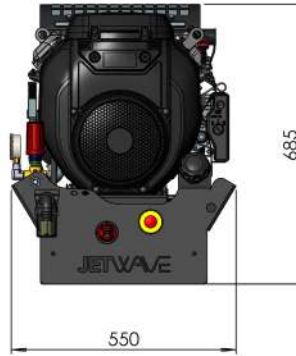
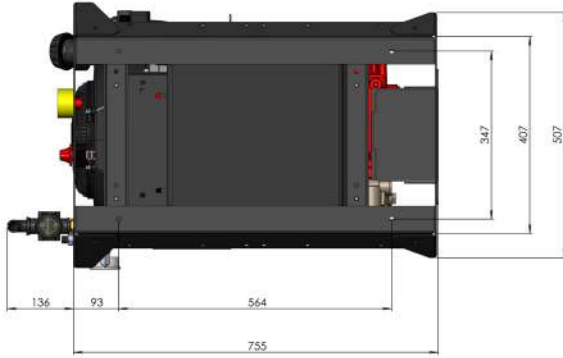

TECHNICAL DATA

PMC C2 JX 350-23

Product Code	PM5000-23PEG2JX
Pressure / Flow Rate	5075 PSI (280 BAR) / 23 L/PM
Max Water Inlet Temp	60C°
Class (ASNZS: 4223)	B (8,050 Bar/Litres)
Usage Frequency	Professional: 4 Hours Daily
Nozzle Size	05
Frame Structure	CNC Modular galvanised steel chassis plus satin powder coat finish

MOTOR FEATURES

Engine / Power	JX750 Electric Key Start (air cooled) 24HP / 750cc
Fuel Type / Capacity / Protection	Unleaded / 25L (w/level gauge) / Low Oil Shutdown



HYDRAULIC FEATURES

Pump / Head / Pistons	JW® Italian Triplex Plunger / Brass (Nickle Plated) / Ceramic
Motor Pump Coupling / Pump RPM	Gearbox Drive / 1450RPM
Unloader Valve	Independent (Panel Mounted)
Safety Valve	Yes

DIMENSIONS & WEIGHT

Machine Dimensions / Weight	890mm(L) x 550mm(W) x 685mm(H) / 130KG (approx.)
-----------------------------	--

WARRANTY(S)

Pump Warranty*	 2 Years
Engine Warranty*	 3 Years

OPTIONAL ACCESSORIES

OPTIONAL UPGRADES

21" Hammerhead - Stainless Steel	JWA-FSC21-5	Internal Bypass Plumbing	JWA-INTERBNP
30" Hammerhead - Stainless Steel	JWA-FSC30		
Professional Nozzle Kit	JWA308		
Remote Mini Reel w/60m 1/4" Hose	PW134-RRCMPL/HOP4		

Copyright © 2023 Jetwave® Group Pty Ltd. All Rights Reserved.

The manufacturer reserves the right to modify design features and technical facts without notice, due to our principals of continuous improvement.

*Coverage against defects in material and workmanship (refer to Jetwave's and component partners T&Cs).

V3.0 03/23



 303 Copland Street, East Wagga Wagga NSW 2650

 equipment@amds.com.au

 (02) 6921 2011 or 0428 212 011

 www.amds.com.au